

Filtros de retorno de cartucho para montagem em linha ou tanque

Filtro de sucção/retorno com elemento descartável

Pressão contínua 12 BAR. Pressão Máxima 30 BAR.

Vazão até 300 lt/min. Temperatura de trabalho -40 a +90°C.

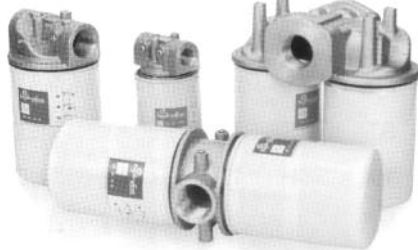

Queda de pressão com óleo 32 ST/30°C

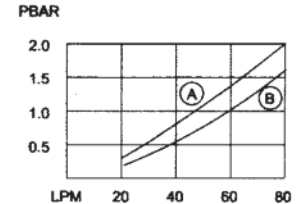

IFR2-06

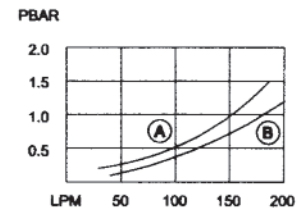

IFR2-10

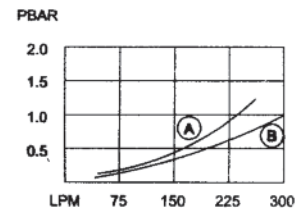

IFR2-12

IF R2	-10	B	-50	-10	B
SERIE	TAMANHO		TAMANHO		ROSCA DO
APLICAÇÃO	CABEÇOTE	TIPO DE	DO	FILTRAÇÃO	CABEÇOTE
	E ROSCA DE	ROSCA	ELEMENTO		COM EL
	ENTRADA E				ELEMENTO
	SAÍDA				FILTRANTE
B- no BYPASS	06 - 3/4"	B - BSPP (STD)	20	10-10 NOM	B - 3/4" BSPP
R- RETURN	10 - 1 1/4"	N - NPT	50	25-25 NOM	U - 1" UNF
S- SUCÇÃO	12V - 1 1/2"	ST - SAE#	65	A10-10 ABS	ROSCA DUAL
	12H - 1 1/2"	S - SAE FLANGE	80	A25-25 ABS	

HYDROLINE	DESCRIÇÃO	FILPRO
HLIFE-50-10B	ELEMENTO 10 MICRONS	FISOE-10/10
HLIFE-50-25B	ELEMENTO 25 MICRONS	FISOE-10/25
HLIFE-65-10B	ELEMENTO 10 MICRONS	FISOE-15/10
HLIFE-65-125B	ELEMENTO 125 MICRONS	FISOE-15/125
HLIFR2-06B-BR4	CABEÇOTE FILTRO BY PASS 25 PSI 3/4"BSPP	FISOH-5/XR
HLIFR2-10B-R4	CABEÇOTE FILTRO BY PASS 25 PSI 1 1/4"BSPP	FISOH-10/XR
HLIFR2-12HB	CABEÇOTE FILTRO DOBLE 15 PSI 1 1/2"BSPP	FISOH-30/R
HLIFR2-12VB	CABEÇOTE FILTRO DOBLE 15 PSI 1 1/2"BSPP	FISOH-20/R
HLIFS2-06B-S1	CABEÇOTE FILTRO BY PASS 3 PSI 3/4"BSPP	FISOH-5/XA
HLIFS2-10B-S1	CABEÇOTE FILTRO BY PASS 3 PSI 1 1/4"BSPP	FISOH-10/XA
HLSE-20-10B	ELEMENTO 10 MICRONS	FISOE-5/10
HLGR-40	MANOMETRO 1/8" ABS	FIVCIP
HLGS-40	VACUOMETRO 1/8" ABS	FIVCIV

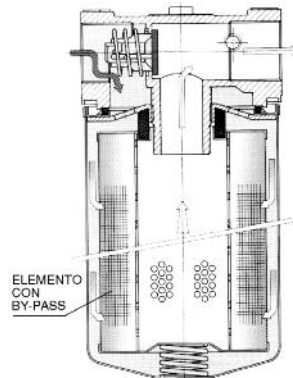

ELEMENTO CON BY-PASS

Nota:
Para utilizar nossos elementos na sucção calcular que admitem só 1/5 del vazão indicado na curva.

SOLICITE PELO CÓDIGO:

ELEMENTO TIPO **IF**

FILTRO COMPLETO



APLICAÇÃO

B= SEM BY-PASS

R= RETORNO

S= SUCÇÃO

TAMANHO

06= 3/4"

10= 1 1/4"

12v= 1 1/2"

12H= 1 1/2"

ROSCA

B= BSPP STANDARD

N= NPT

ST= UNF

S= BRIDA SAE (SÓLO PARA 12H)

ROSCA DO ELEMENTO

B= 06 3/4" BSPP

U= 06 1" UNF

OUTROS TAMANHOS DUAS ROSCAS

FILTRAÇÃO

10= 10µm NOMINAL

25= 25µm NOMINAL

A10= 10µm ABSOLUTO

A25= 25µm ABSOLUTO

TAMANHO DO ELEMENTO

20= CABEÇOTE 06

50= CABEÇOTE 10

65= CABEÇOTE 12V

80= CABEÇOTE 12H

ROSCA PARA MANÓMETRO

R= 2 ROSCAS 1/8 NPT COM ENTRADA

S= 2 ROSCAS 1/8 NPT COM SAÍDA

B= 4 ROSCAS 1/8 NPT

COM ENTRADA E SAÍDA

VÁLVULA BY-PASS

R3= RETORNO STANDARD 1 BAR

R4= RETORNO STANDARD 1,7 BAR

S1= SUCÇÃO STANDARD 0,2 BAR

S2= SUCÇÃO STANDARD 0,34 BAR

Maiores informações, consulte nosso depto de vendas técnicas.



ISO 9001

FILTRO COMPLETO

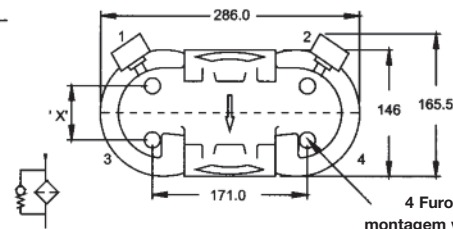
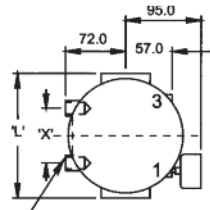
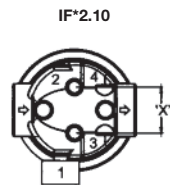
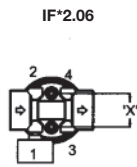
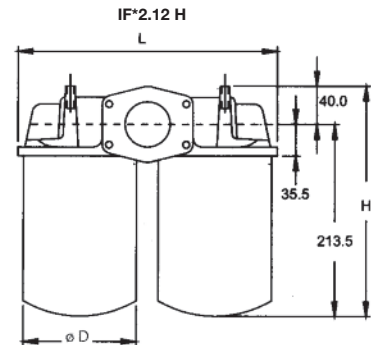
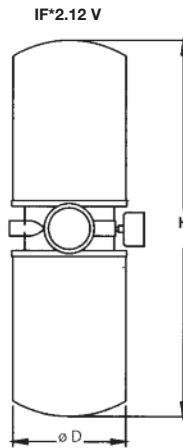
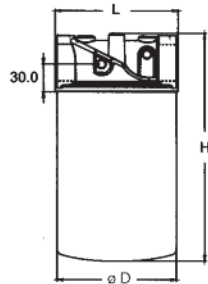
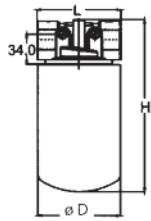

2 Furos de montagem ver tabela

4 Furos de montagem ver tabela

FILTRO COMPLETO:

MODELO	L	ø D	H	X	FURO DE MONTAGEM		CONEXÃO MANÔMETRO		PESO KGS
					CANT	ROSCA	CANT	ROSCA NPT	
1) IF*2.06.20	95	95	196	38	2	M 6x1.0	1	1/8"	1.0
2) IF*2.10.50	132	129	247	50	2	M 8x1.25	1	1/8"	2.3
3) IF*2.10.65	132	129	287	50	2	M 8x1.25	1	1/8"	2.5
4) IF*2.10.50	132	129	426	50	2	M 8x1.25	1	1/8"	2.5
5) IF*2.12V.65	148	129	506	65	2	M 10x1.5	2	1/8"	3.4
6) IF*2.12V.50	148	129	506	65	2	M 10x1.5	2	1/8"	3.4
7) IF*2.12V.65	286	129	291	60	4	M 10x1.5	2	1/8"	5.0

TIPOS DE FILTRO:

IF R2	-10	B	-B
MODELO	TAMANHO	CONEXÃO	ROSCA
B - Sem BAY PASS	06 - 3/4"	B - BSPP (STD)	B - 3/4" BSPP
R - RETORNO	10 - 1 1/4"	N - NPT	U - 1" UNF a pedido
S - SUCÇÃO	12V - 1 1/2"	ST - SAE#	ROSCA DUPLA
	12H - 1 1/2"	S - BRIDA SAE (só para 12H)	

CABEÇOTES:

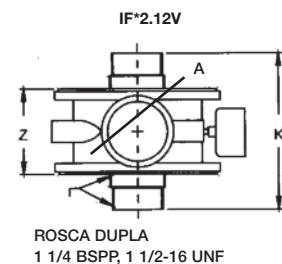
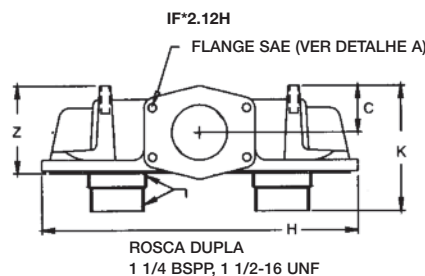
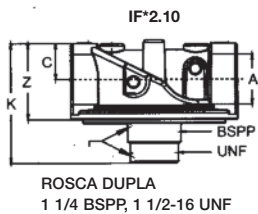
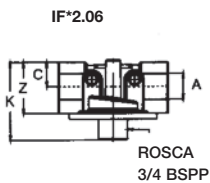

ELEMENTOS:

Rosca B - 3/4" BSP

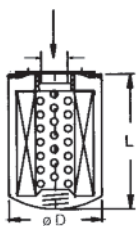

Rosca B - 1 1/4" BSP

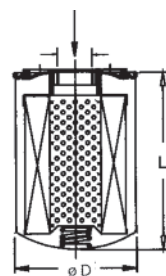

DETALHE A

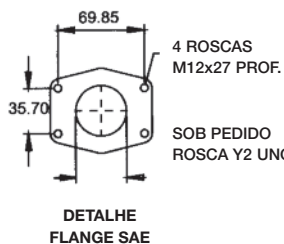

ELEMENTO	FILTRAÇÃO		PESO
MODELO	D	L	area cm ² kgs
S/E-20-**-*	96	145	2100 0.7
IFE-50-**-*	129	180	5600 1.2
IFE-65-**-*	129	222	7500 1.3

ROSCAS E MEDIDAS

MODELO	PORT ROSCA A	PORT ROSCA B	C	K	Z	H	PESO kgs CABEÇOTES
IF* 2.06 B	3/4"BSPP	3/4" BSPP	22	67	45	-	0.3
IF* 2.06 U	3/4"BSPP	1" UNF x 12					
IF* 2.10 B	1 1/4"BSPP	dupla	29	96	61	-	1.1
IF* 2.12 V B	1 1/2"BSPP	dupla	-	140	70	-	1.0
IF* 2.12 H B	1 1/2"BSPP	dupla	40	107	76	286	2.5
IF* 2.10 H S	1 1/2"brida SAE	dupla					

GRADO DE FILTRAGEM

***	-50	-10	B
MODELO	TAMANHO	FILTRAÇÃO	ROSCA
S/E	20	10 - 10 NOM 25 - 25 NOM	B - 3/4" BSPP U - 1 1/2" UNF a pedido
IFE	50 65	A10 - 10 ABS A25 - 25 ABS	B - 1 1/4" BSPP

Maiores informações, consulte nosso depto de vendas técnicas.